

FLOW METER:	N/A
CONNECTION:	N/A
HDR:	1" X 1" PULTRUSION
ACCESSORIES:	NONE

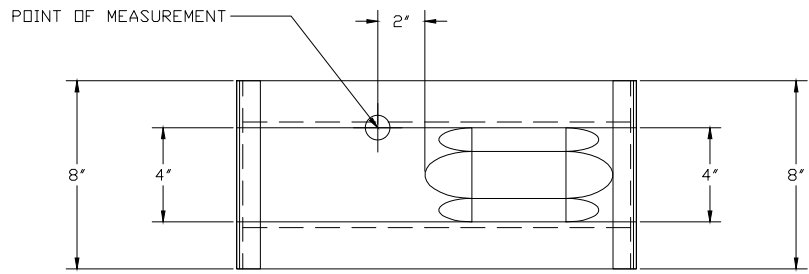

PLAN VIEW

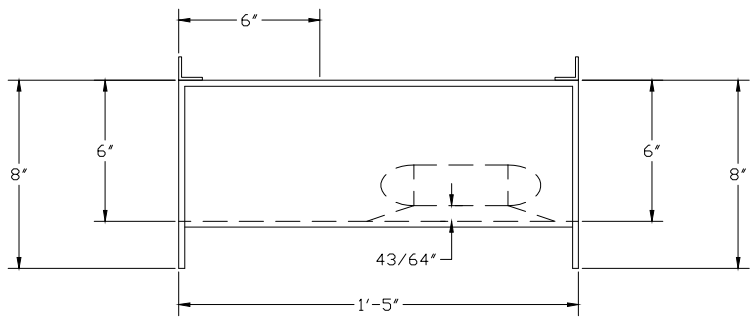

RIGHT ELEVATION

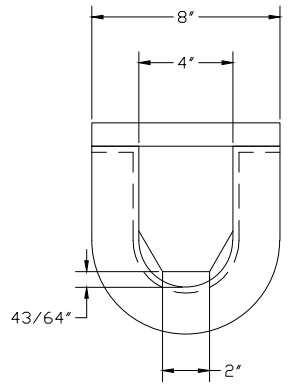

DISCHARGE ELEVATION

1) FLOW IS FROM LEFT TO RIGHT

	PALMER-BOWLUS FLUME, SIZE 4", 4D+1" STYLE	
	DWG. NO. PB-4-4D-N-N-N-N-N-N	REV 0
PROJECT	STANDARD FLUME SIZE	DATE 5/28/03