

FLOW METER:	N/A
CONNECTION:	N/A
HDR:	2" X 2" PULTRUSION
ACCESSORIES:	NONE

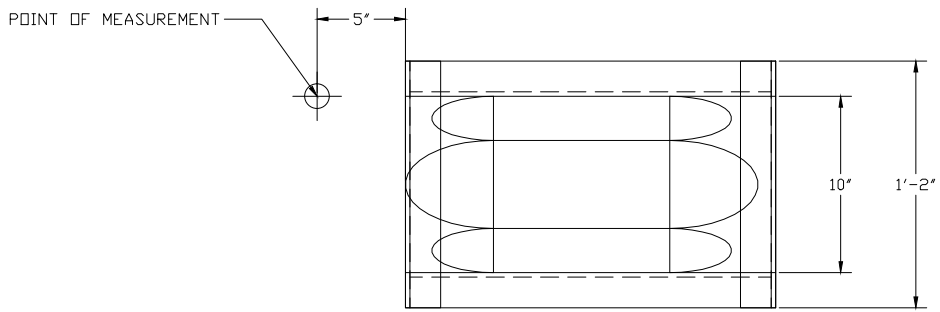

PLAN VIEW

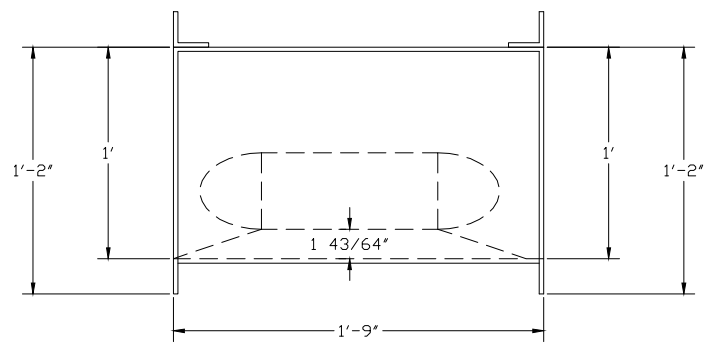

RIGHT ELEVATION

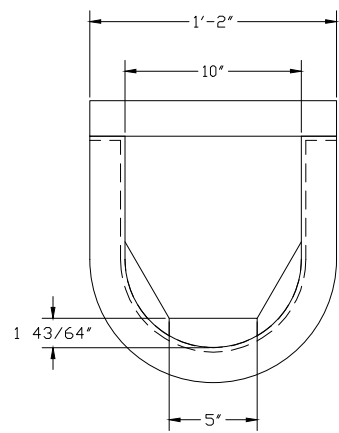

DISCHARGE ELEVATION

1) FLOW IS FROM LEFT TO RIGHT

	PALMER-BOWLUS FLUME, 10 INCH SIZE, 2D+1" STYLE	
	DWG. NO. PB-10-2D-N-N-N-N-N-N-N	REV 0
PROJECT	STANDARD FLUME SIZE	DATE 11/16/04