

FLOW METER:	N/A
CONNECTION:	6" DIA. C.I./PVC PIPE
ACCESSORIES:	NONE

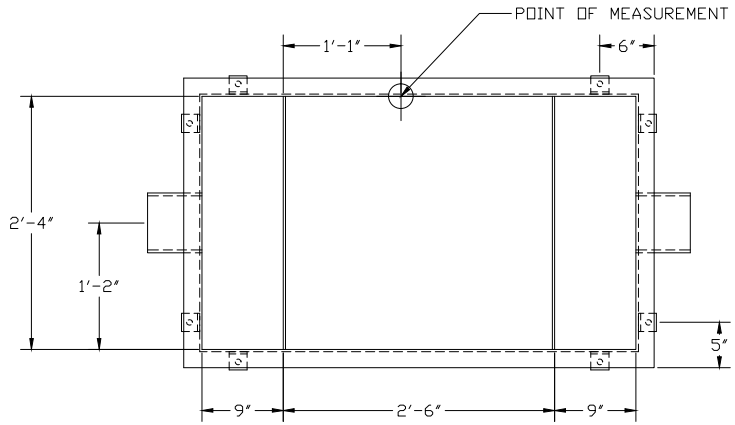

PLAN VIEW

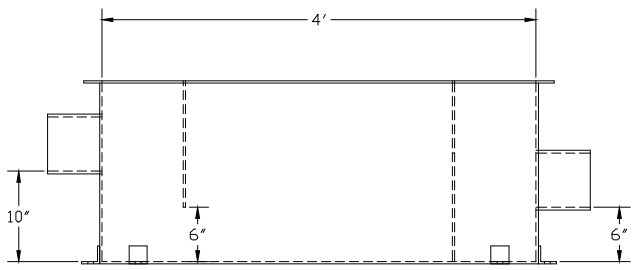

RIGHT ELEVATION VIEW

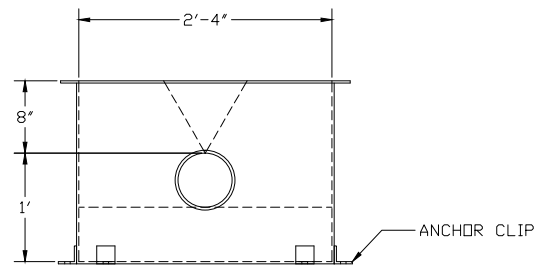

DISCHARGE ELEVATION VIEW

- 1) FLOW IS FROM LEFT TO RIGHT
- 2) SIZED PER ISO 1438/1-1990
- 3) OPEN CHANNEL CONDITIONS MUST BE PRESENT
- 4) FIXED 60° V-NOTCH WEIR AND BAFFLE PLATES
- 5) SIDE STIFFENING RIBS NOT SHOWN FOR CLARITY

 FIBERGLASS PRODUCTS	MEDIUM WEIR BOX, 28" W X 48" L X 20" H, WITH FIXED 60° V-NOTCH WEIR PLATE, FIXED BAFFLE PLATE, 6" PIPE STUBS	
	DWG. NO. WB-MED-60V-B-P6-N-N-N-N	REV 0
PROJECT STANDARD WEIR BOX SIZE	DATE 8/24/12	