

EXTERIOR COLOR: #2445 GRAY CLOUD	LOAD CENTER: 125 A, M.L. 120/240 VAC, 1P
INTERIOR COLOR: #2445 GRAY CLOUD	NEMA 1 - SIEMENS E08ML1125AS
INSULATION: 1" (R~7)	LIGHT: 100 WATT INCAN. - M 14915K54
DOOR HDR: SCHLAGE SS CLASSROOM STYLE	FAN: 585 CFM - G 2C819
SS STRAP HINGES	SHUTTER: 10" X 10" - G 5C210
SS SPRING CUSHIONED CRASH STOP	HEATER: 1500 WATT - G 5ZK68 & G 5ZK72
ACCESSORIES: NONE	OUTLET: GFCI - LEVITON

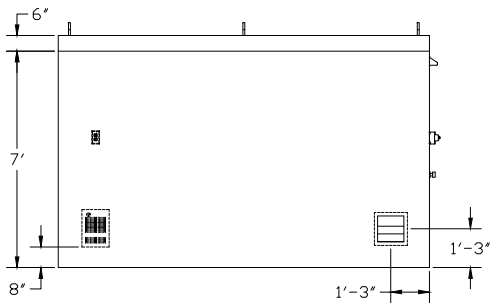

LEFT ELEVATION

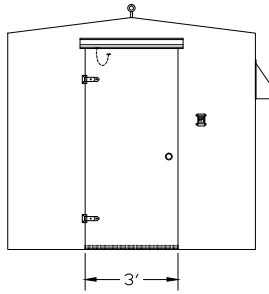

FRONT ELEVATION

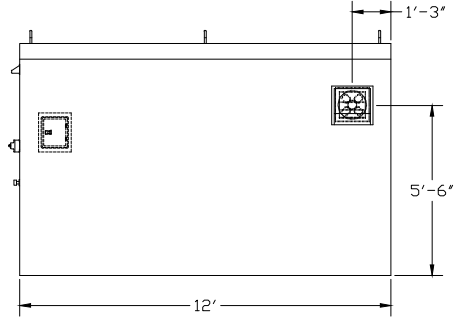

RIGHT ELEVATION

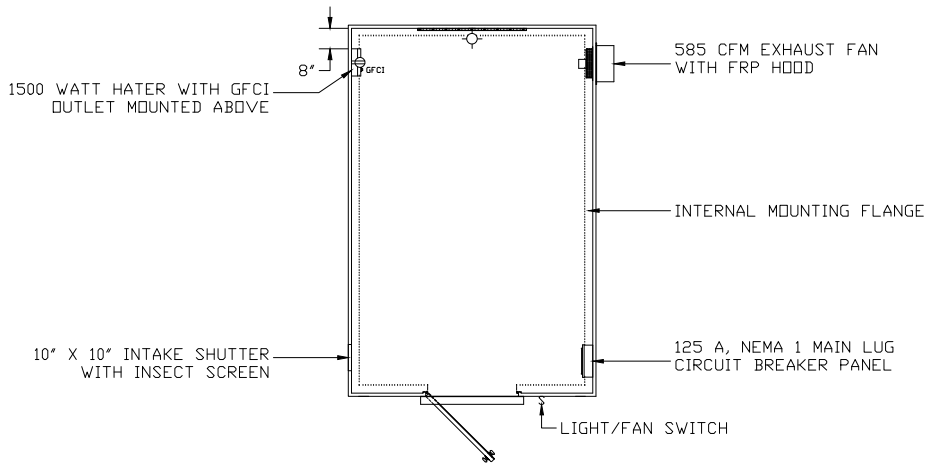

PLAN VIEW

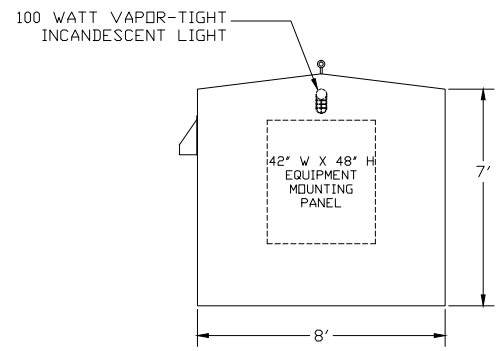

REAR ELEVATION

1) ANCHOR BOLTS BY OTHERS

	ONE-PIECE FRP BUILDING, 8'-0" W X 12'-0" D X 7'-6" H WITH STANDARD ACCESSORIES PACKAGE	
	DWG. NO. OPB-96-144-90-01	REV 0
PROJECT	STANDARD BUILDING SIZE	DATE 9/22/04