

EXTERIOR COLOR:	#1555 WHALE BONE
INTERIOR COLOR:	#1555 WHALE BONE
FINISH:	SATIN
HDR:	SOUTHCO TYPE 44 LATCHES
ACCESSORIES:	NONE

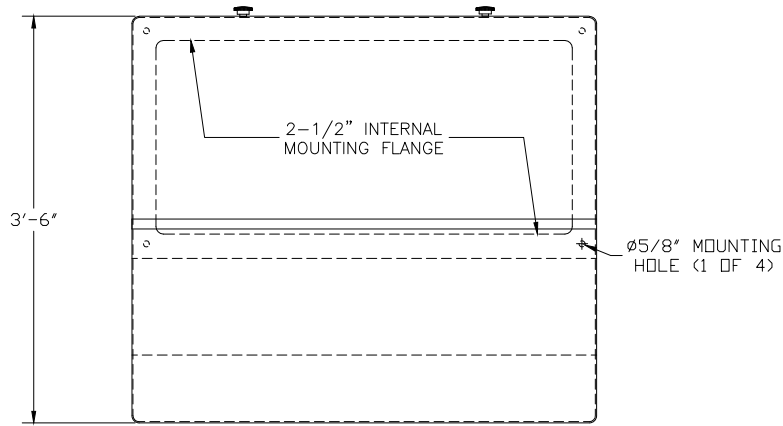

PLAN VIEW

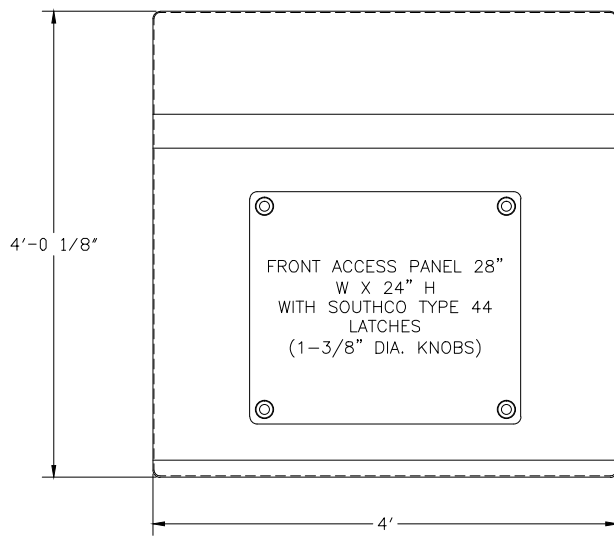

FRONT ELEVATION

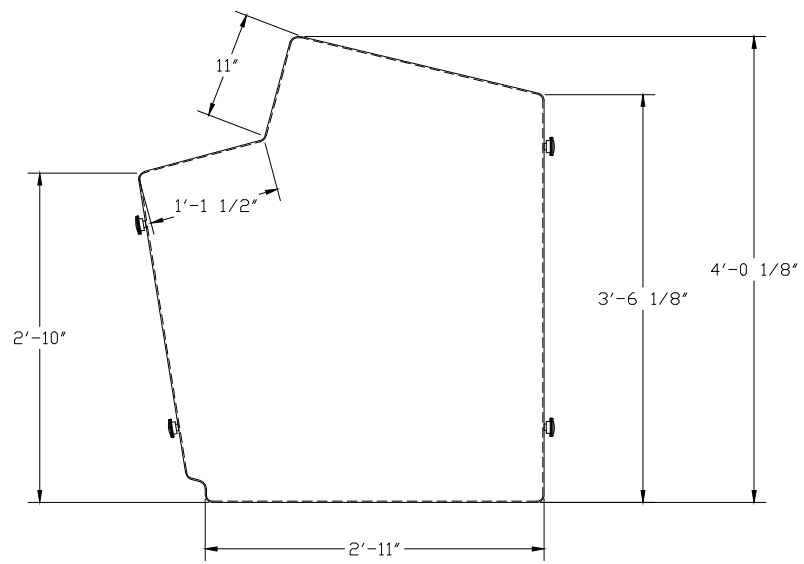

RIGHT ELEVATION

- 1) (1) FRONT ACCESS PANEL (28" W X 24" H)
- 2) (1) REAR ACCESS PANEL (28" W X 32" H)

 FIBERGLASS PRODUCTS	SERIES 1500 CONTROL CONSOLE, 48" W X 42" D X 48-1/8" H, WITH SATIN WHALE BONE GEL COAT	
	DWG. NO. CON-LB-48-S-1555-N-N-N	REV 0
PROJECT	STANDARD CONSOLE SIZE	DATE 8/6/04