

FLOW METER:	N/A
CONNECTION:	N/A
HDR:	2" X 2" PULTRUSION
ACCESSORIES:	NONE

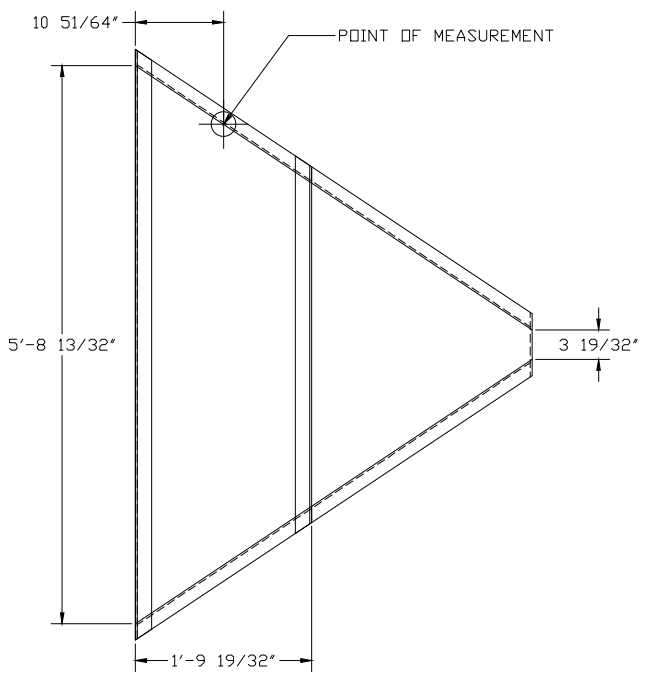

PLAN VIEW

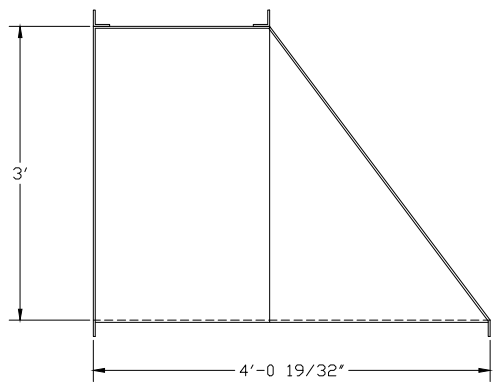

RIGHT ELEVATION

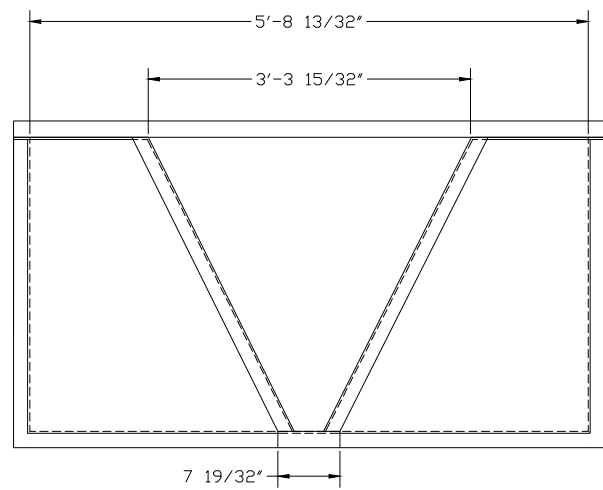

DISCHARGE ELEVATION

1) FLOW IS FROM LEFT TO RIGHT

	3.0' H-FLUME	
	DWG. NO. H3.0-N-N-N-N-N-N-N	REV 0
PROJECT	STANDARD FLUME SIZE	DATE 9/16/03