

EXTERIOR COLOR: #1555 WHALE BONE	DOOR HDR: SS PIANO HINGES - M 1582A115
INTERIOR COLOR: #1555 WHALE BONE	SS LOCKABLE HASP - M 1304A24
INSULATION: NONE	(2) SS STOP CHAINS
ACCESSORIES: NONE	(2) LIFT HANDLES - M 13665A27

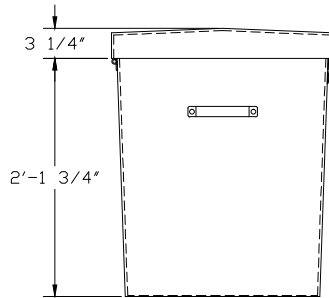

LEFT ELEVATION

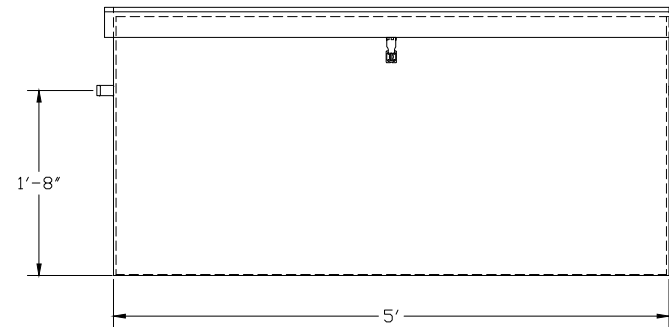

FRONT ELEVATION

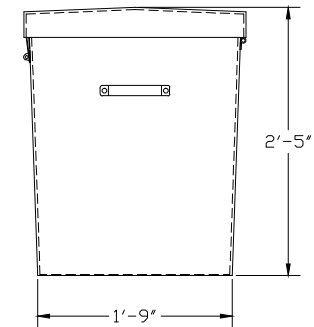

RIGHT ELEVATION

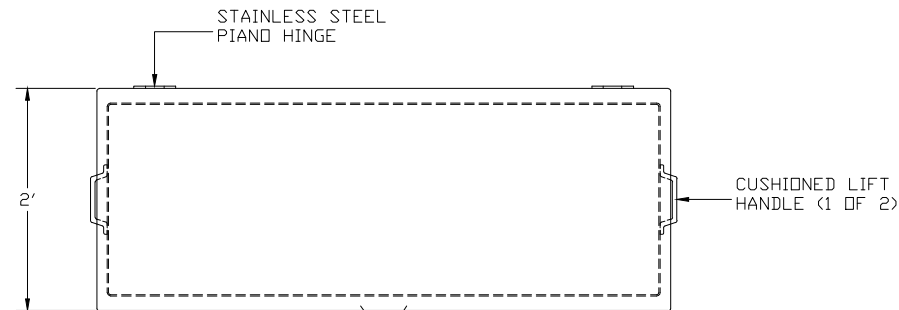

PLAN VIEW

- 1) INTEGRAL FLOOR
- 2) (2) STAINLESS STEEL LID-STOP CHAINS NOT SHOWN FOR CLARITY

 FIBERGLASS PRODUCTS	MODEL 200-060-60 ENCLOSURE, 60" W X 21" D X 29" H	
	DWG. NO. ENCL-200-060-60-01	REV 0
PROJECT STANDARD ENCLOSURE SIZE	DATE 1/4/00	