

EXTERIOR COLOR: #2445 GRAY CLOUD	LOAD CENTER: 125 A, M.L. 120/240 VAC, 1P
INTERIOR COLOR: #2445 GRAY CLOUD	NEMA 1 - SIEMENS E08ML1125AS
INSULATION: 1" (R~7)	LIGHT: 100 WATT INCAN. - M 14915K54
DOOR HDR: SS SCHLAGE CLASSROOM STYLE	FAN: 585 CFM - G 1HLA1
SS STRAP HINGES	SHUTTER: 10" X 10" - G 5C210
SS SPRING CUSHIONED CRASH STOP	HEATER: 1500 WATT - G 5ZK68 & G 5ZK72
ACCESSORIES: NONE	OUTLET: GFCI - LEVITON

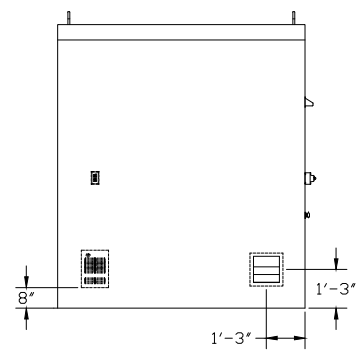

LEFT ELEVATION

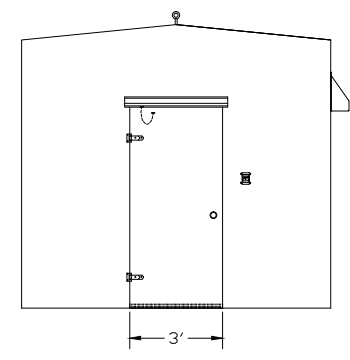

FRONT ELEVATION

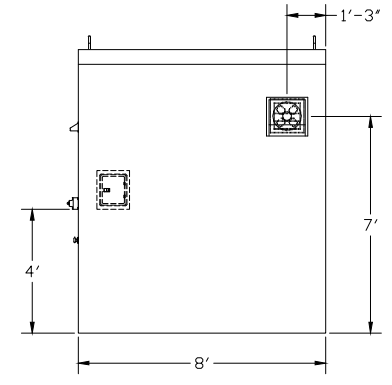

RIGHT ELEVATION

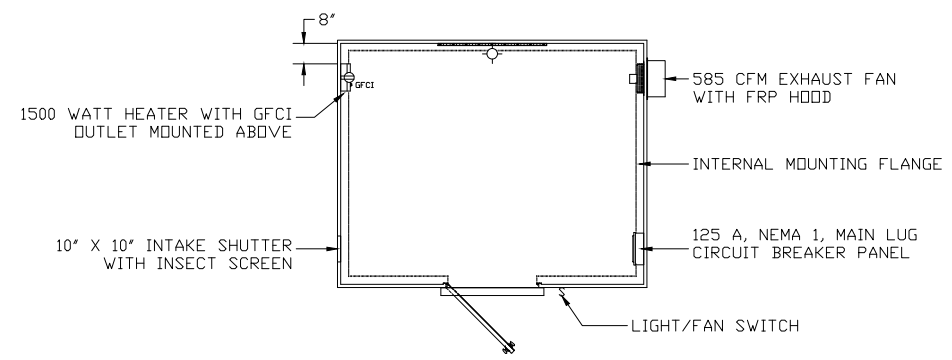

PLAN VIEW

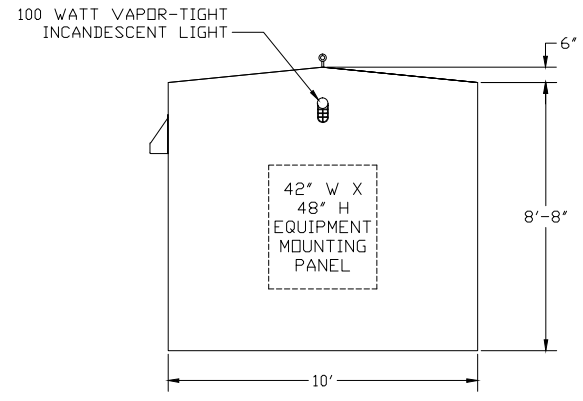

REAR ELEVATION

1) ANCHOR BOLTS BY OTHERS

	ONE-PIECE FRP BUILDING, 10'-0" W X 8'-0" D X 9'-2" H, WITH STANDARD ACCESSORIES PACKAGE	
	DWG. NO. OPB-120-96-110-01	REV 0
PROJECT	STANDARD BUILDING SIZE	DATE 2/7/04